

## CHAPTER 8

# 3-MAN SYSTEM

### 3-MAN ROTATION

#### GENERALIZATIONS

Always, regardless of outs, on runner moving 1st to 3<sup>rd</sup>.  
Never with runner in scoring position  
Revert to 2-man system in infield when either base umpire goes into the outfield  
Less than 2 outs, cover the lead runner; with 2 outs, cover 1B

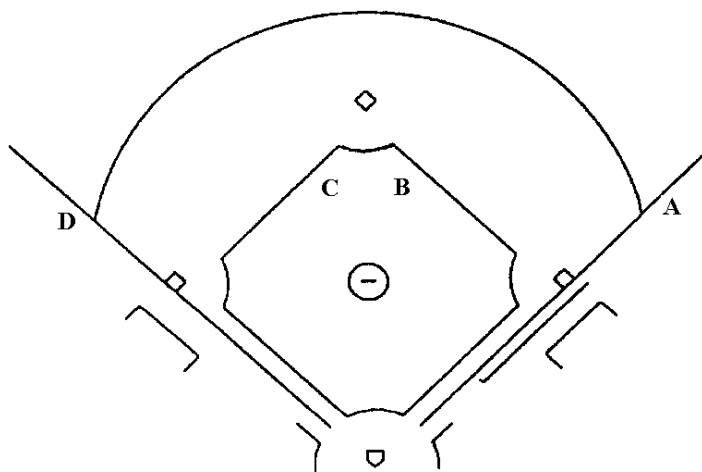

#### **Plate Umpire (PU) Responsibilities**

1. Both foul lines up to the base.
2. Batter-runner to 1B when the 1BU goes out.
3. Batter-runner to third if 3BU goes out.
4. Batter-runner inside the 45 foot lane to 1B.
5. Stays home with 2 outs and or runner in scoring position.

#### **First Base Umpire (1BU) Responsibilities**

1. Right field foul line from front of base to fence.
2. All fly balls to outfield from center fielder to right field foul line.
3. Low line drives to F3 & F4, coming toward 1BU.
4. Check swings on right handed batter.
5. Batter-runner to second base on ball in gap to left or down the left field line.
6. 1BU keys off 3BU on center fielder coming straight in to play on batted ball.

#### **Third Base Umpire (3BU) Responsibilities**

1. Left field foul line from front of base to fence.
2. All fly balls from center to left field foul line including F8 straight in.
3. Low line drives to F6 and F5, coming toward 3BU.
4. Touch of 2B on double or triple from center field to right field line.
5. Check swing on left handed batter.
6. Batter-runner into 2B when 1BU goes out.
7. When pitching changes occur, count warm-up pitches.

### **Other Coverage's**

1. Plate umpire takes runner from 1B to 3B on base hit with runner starting at 1B.
2. Base umpires go out on all fly balls or trouble balls in his area of responsibility.
3. Only one umpire makes call on fly ball catch/no catch.

### **In Between Innings**

1. Do not come in to the plate area to talk to HP.
2. Hold your position at 1B & 3B. 1BU should stand behind 1B in fair territory and 3BU behind 3B in fair territory. Do not go to the fence area to talk to anyone.
3. Head for positions when F2 readies to throw to 2B after final warm-up pitch. Stay away from coaches' boxes or players between innings.

### **Pre-Game Procedures**

1. All umpires meet prior to going on field. Walk to home plate together, lead by the umpire whose base is opposite the entrance to the field with HP in middle.
2. Let HP do all the talking in pre-game conference.
3. Stand in front of home plate lined up on the side of your assignment

### **Abbreviations:**

- HP – Home Plate Umpire
- 1BU – First Base Umpire
- 3BU – Third Base Umpire
- BR – Batter-runner

### **General Information**

1. 1BU & 3BU check bats and equipment approximately 15 minutes before entrance to field. Go together into the dugout to do this.
2. Fair/Foul Calls – HP takes all calls up to the base. Base umpires have the bag and beyond.
3. Check Swings – 3BU calls left handed batters. 1BU calls right handed batters
4. On any coverage, do not take anything for granted. Use good verbal and visual communication to ensure that all plays are covered properly. Get the call right.
5. 3BU takes control on fly balls to center field when F8 comes straight in.
6. If a BU goes out on a fly or trouble ball, he should stay out until the play is completed.

### **Fly Ball Coverage**

3BU is responsible for outfield from left field foul line to center field, including F8 coming in. 1BU is responsible for area from right field line to center field. With runners on base, umpire should not go out unless necessary (trouble ball). Never leave the infield from Positions B or C to observe play in the outfield.

## OTHER COVERAGE

When 1BU is at 1B with runners on base, 3BU moves to Position C. Check the umpire on the open side of the batter always handles swing appeals. With 3BU at Position D, 1BU is at Position B.

## BASES EMPTY

Fly ball to left field. When 3BU goes out to cover fly ball, 1BU glances to observe touch of 1B & takes BR to 2B & 3B. HP stays home. We revert back to two man system when one umpire goes out.

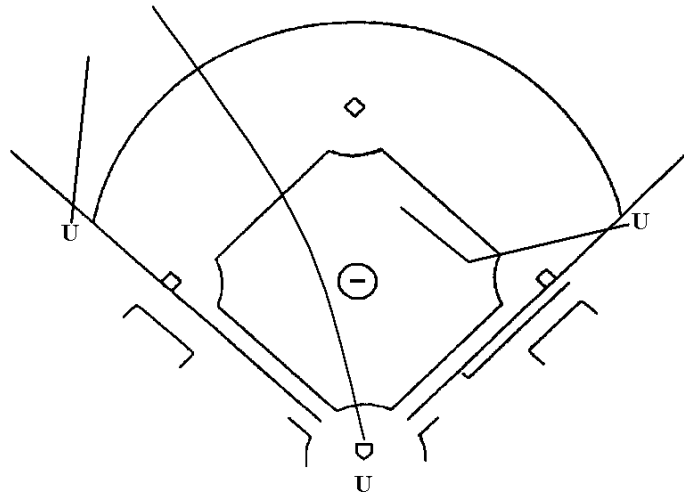

Fly ball to right field. When 1BU goes out, HP takes tag at 1B and return play there, then returns home. 3BU covers plays at 2B and 3B. 1BU remains out of infield coverage.

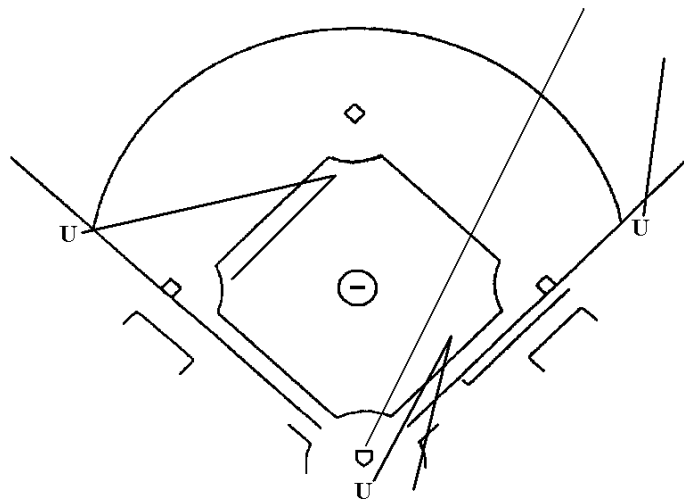

## FLY BALL TO RIGHT FIELD

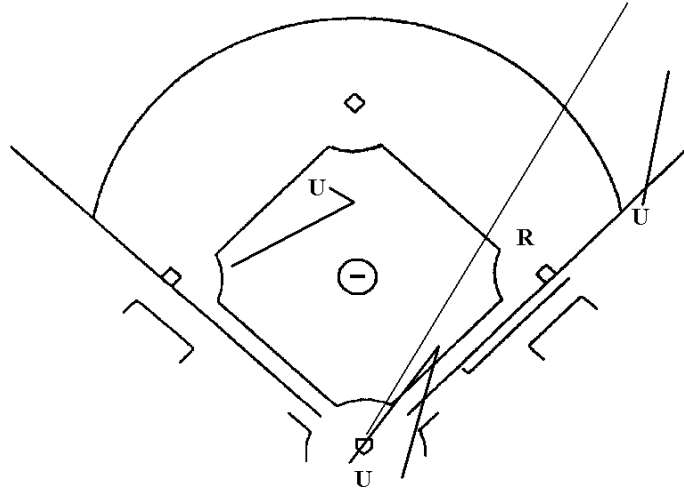

### Runner on 1B

1BU goes out, and we have a catch. U3 slides to cover throw back to first. If it is not a catch then HP umpire rotates to third if the ball and the runner takes him there. On a wild throw to third HP umpire must retreat back home (in fair territory) to cover play there.

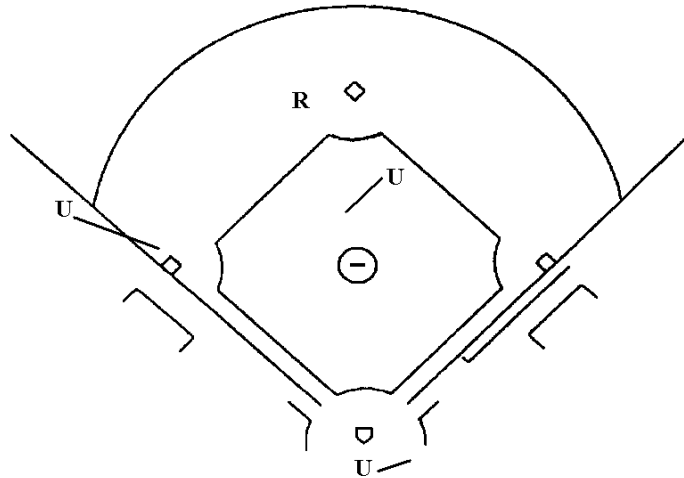

### Runner on 2B

1BU takes tag up at 2B and catch unless the ball is hit toward the right field line (which HP calls). 3B takes play at 3B. HP stays home.

**Runners on 1B and 2B  
(less than 2 outs)**

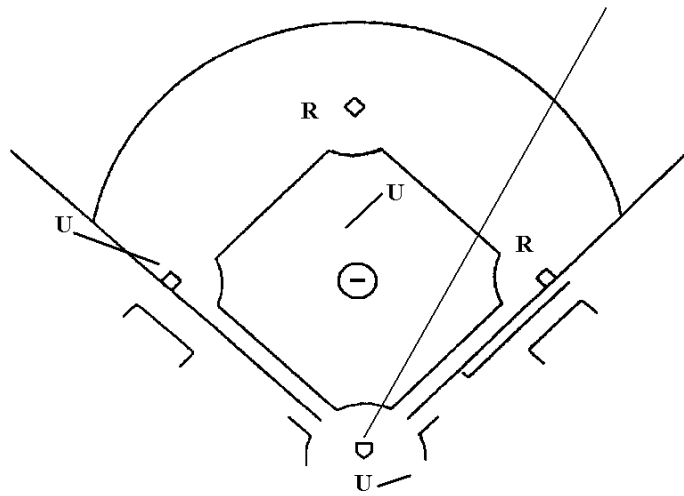

1BU takes fly ball and the tag at 1B. 3BU takes tag at 2B and plays at 3B. HP takes play at home.

**Runners at 2B and 3B  
(Less than 2 outs)**

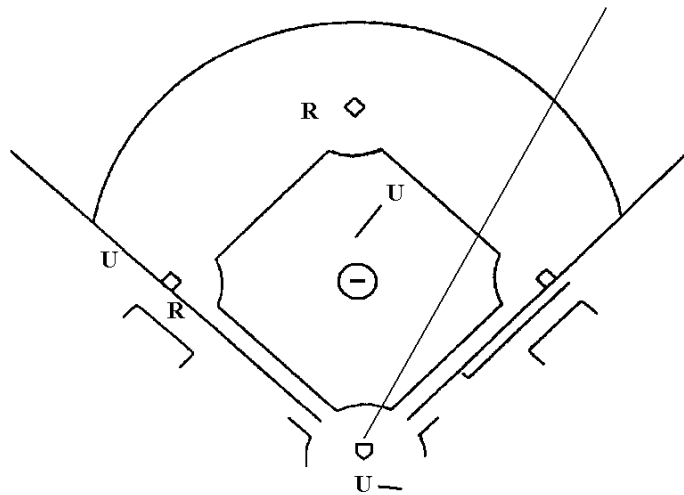

With two outs base umpires rotate back to Positions A and C.  
If 1BU goes out, 3BU takes tag at 2B and any play at 2B or 3B. HP has tag at 3B and any play at home.

### Runners at 1B and 3B

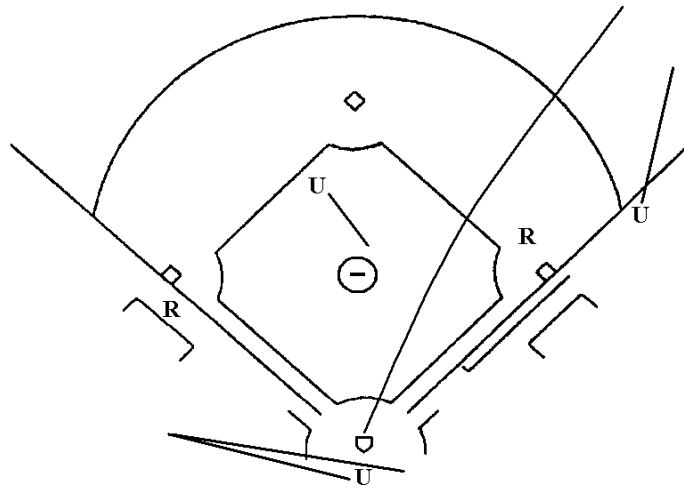

If 1BU goes out, 3BU takes the tag at 1B and any Play at 1B and 2B. HP then rotates to third for play there. (like two man). On a straight hit. HP after watching runner touch home would rotate to third for play there. 1BU walks the line to rotate to home for possible play there. (COMMUNICATE).

### Bases Loaded

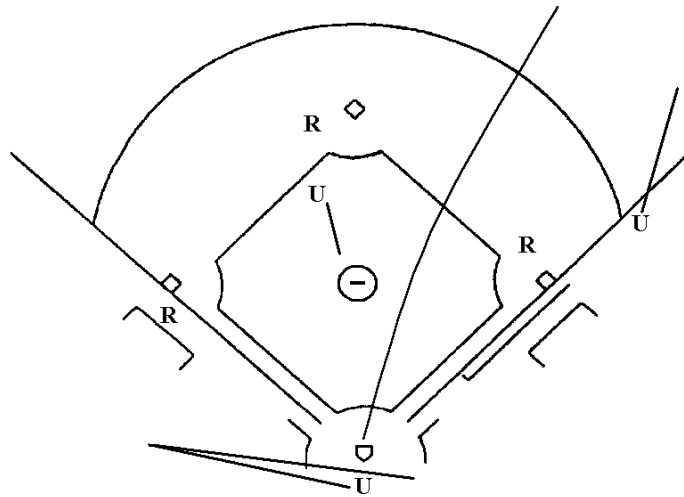

If 1BU goes out, 3BU takes tags at 1B and 2B and any plays at any base. HP takes tags at 3B and any play at home.

**One base hit  
(No runners)**

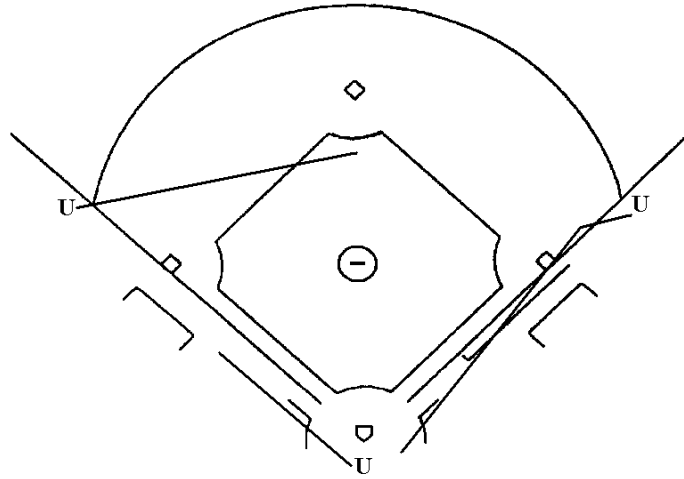

3BU covers 2B and 1B, if necessary (runner returns to 1B after 1BU has released to the plate). If batter-runner continues to 3B, HP covers play at 3B and 1BU covers the plate (1BU releases to plate after the touch of 1B by batter-runner).

**Single with runner on 1B**

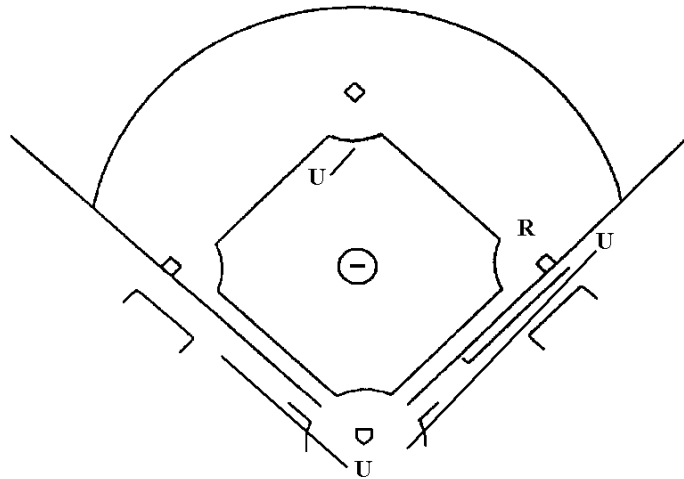

HP drifts to 3B to cover plays there. 1B takes the tag at 1B by batter-runner and releases for the plate. 3BU remains in the middle infield to take plays at 2B and 1B after 1BU releases for the plate. (COMMUNICATE)

**Single with a runner at 2B**

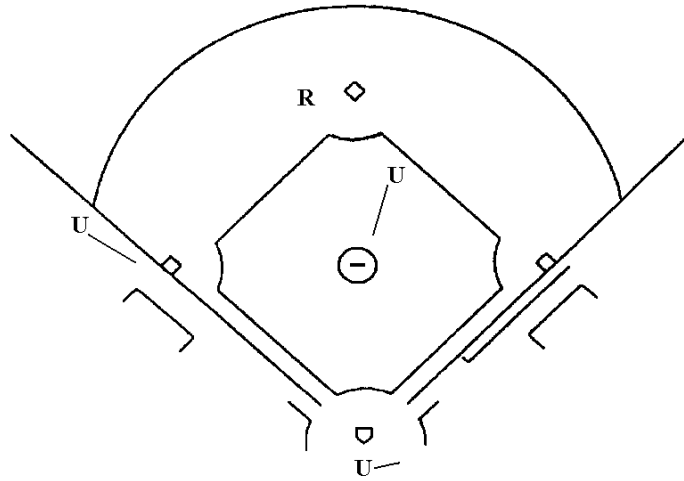

HP stays home to cover plays there. 1BU covers play at 1B or 2B. 3BU covers play at 3B.

**Single with runners at 1B and 3B**

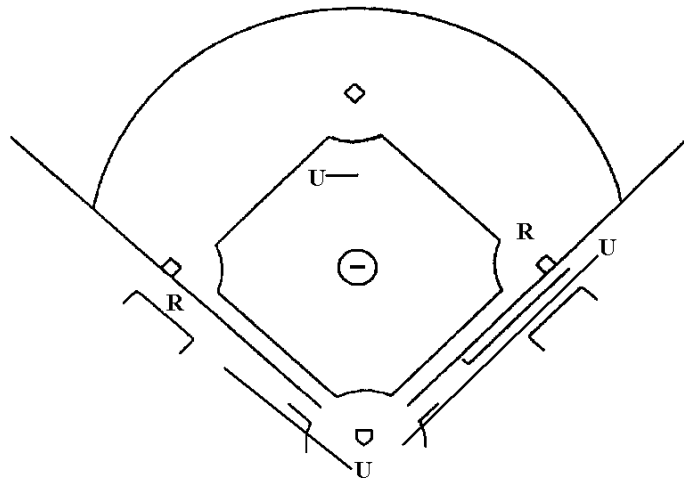

HP covers play at 3B and 1BU rotates to the plate. 3BU covers plays at 2B and 1B after 1BU drifts to the plate (must watch batter-runner touch 1B while on the way to home plate).

### Single with bases loaded

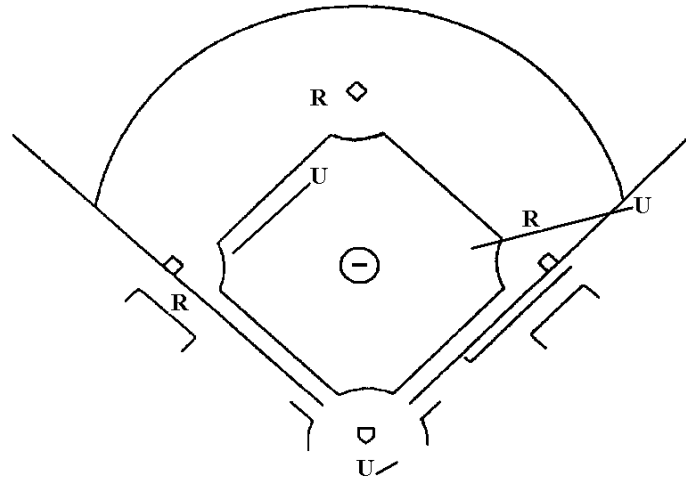

HP stays at the plate. 3BU covers any plays at 2B and 3B. If 3B goes to 3B, 1B must cover plays at 2B. 1BU must make sure you come in and buttonhook on this play. Don't walk the line. Have to be inside the diamond.

### Base hit into the gap (possible extra base hit)

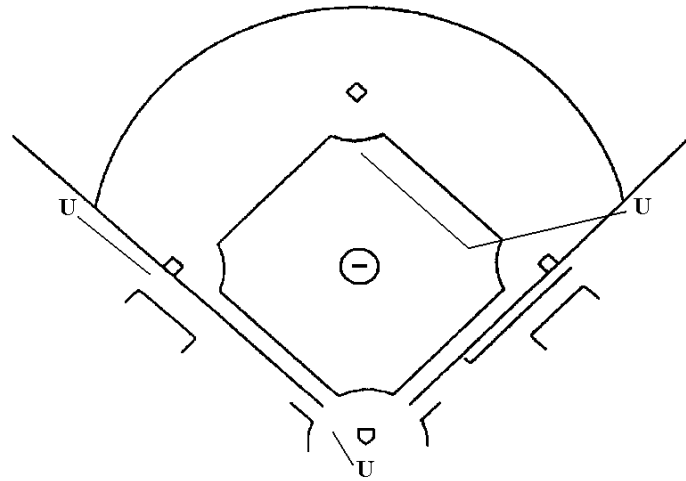

Regardless of which BU goes out, the other two umpires revert to two-man system in the infield. In this diagram, neither BU goes into the outfield.

### Positions between innings

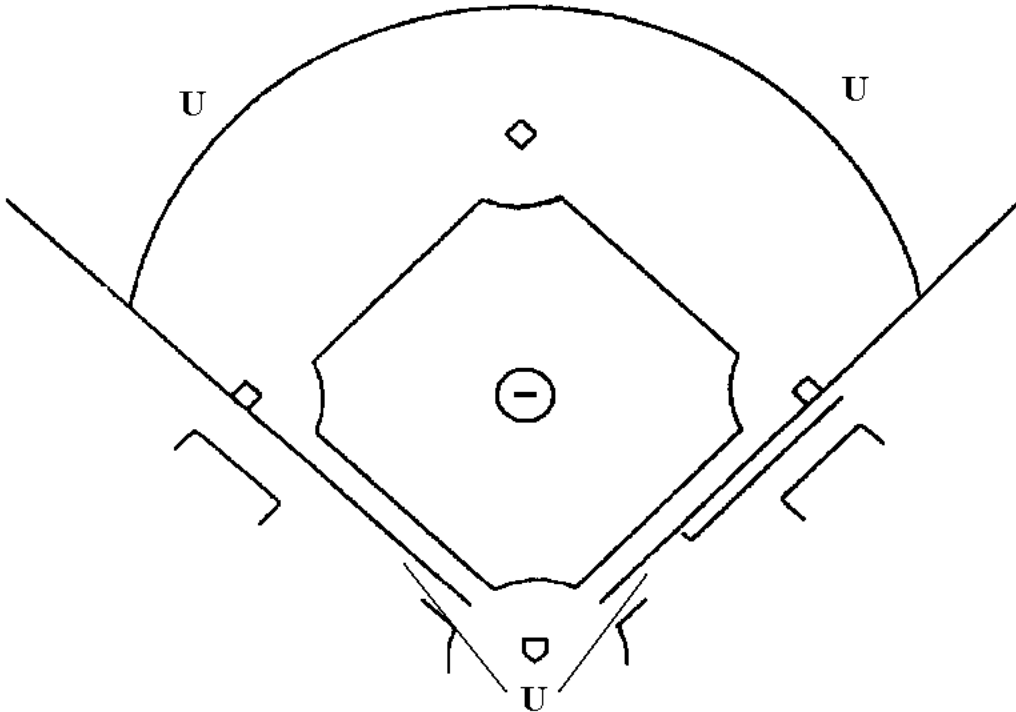

HP stands up the baseline on either 3B or 1B side. The side is generally the one away from the team entering the field on defense. 3BU stands on the outfield grass behind 3B. 1BU stand on the outfield grass behind 1B.

Base umpires do not come into the plate umpire between innings.